

Altura máxima bajo gancho sin arriostrar (m). Maximum height under hook without fastening (m). Hauteur maximale sous crochet sans ancrage (m). Максимальная высота под крюком без крепления (m). Bağlantısız maksimum kanca altı yüksekliği (m). أقصى ارتفاع تحت الخطاف بدون ربط (m)	Pluma / Jib (I) * ..... 134.40.700 Pluma / Jib (II) ..... 134.41.000 Pluma / Jib (III) ..... 124.42.000 Pluma / Jib (IV) ..... 134.43.000 Punta Pluma / Jib End** ..... 111.45.000 TMU 1.18 ..... 202.35.500 TR 12 ..... 146.30.000 T 12 ..... 126.31.500 TR 8RM ..... 202.30.000 TR 8M ..... 146.30.800 TR 4 ..... 800.32.300 T 4 ..... 126.32.000	TN 2 ..... 146.32.500 AR 12 ..... 137.21.000 AN 12 ..... 146.21.000 BTX 45/BEX 45 ..... 137.20.500 BTX 38R/BEX 38R ..... 137.20.000 BTX 38/BEX 38 ..... 149.20.000 BTX 28/BEX 28 ..... 149.20.500 BE 442 ..... 146.24.850 BE 434 ..... 146.24.950 ABH 75 ..... 152.23.000 ABH 90 ..... 146.23.000
---	--	---

H<sub>SR</sub> =

H<sub>SR</sub> - 2 m.



\* Pluma / Jib / Flèche / Стрела / Bom / ذراع  
 \*\* Punta de pluma / Jib end / Pointe de flèche / Конец стрелы / Bom ucu / مقدمة الذراع

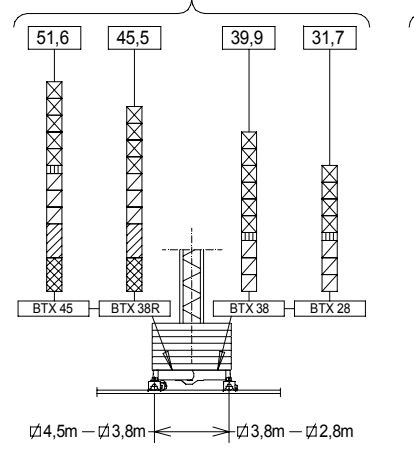



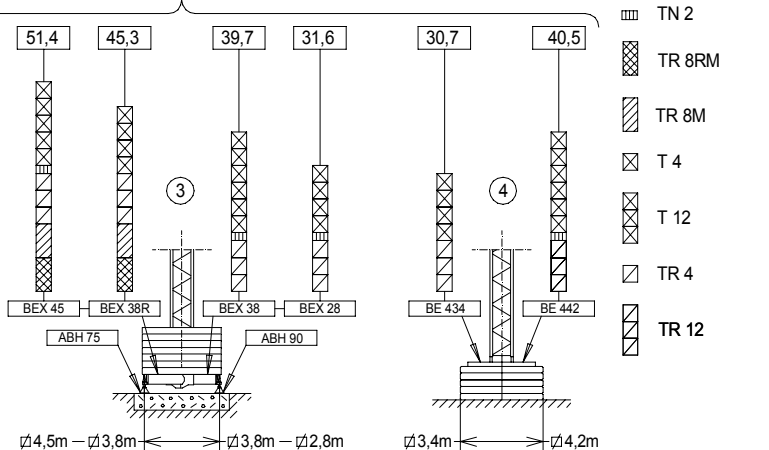





(H) TRASLACIÓN / TRAVELLING /  
 TRASLATION / ПЕРЕМЕЩЕНИЕ / RAY YÜRÜYÜŞÜ / متحركة



(H) ESTACIONARIA / STATIONARY /  
 STATIONAIRE / СТАЦИОНАРНОЕ СОСТОЯНИЕ / SABIT / ثابتة

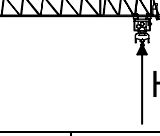

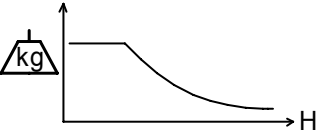
CARGAS / LOADS / CHARGES / НАГРУЗКИ / YÜKLER / الأحمال								J36MAC	
	SR (kg)	Cargas máximas / Maximum loads / Charges maximales / Максимальные нагрузки / Maksimum yük / أقصى حمولة / SR-2000 kg						2000 kg	
	Alcance del gancho [m] / Hook reach [m] / Portée du crochet (m) / Радиус действия крюка (m) / Kancanın yüksekliği (m) / مدى الخطاف [m]	35	32	30	27	25	22	20	@...[m]
35 m	1000	1075	1200	1350	1475	1700	1895	19	
30 m	—	—	1300	1465	1600	1840	2000	20,41	

CARACTERISTICAS DE MECANISMOS / MECHANISMS FEATURES / CARACTÉRISTIQUES DES MÉCANISMES / ХАРАКТЕРИСТИКИ МЕХАНИЗМОВ / MEKANİZMALARIN ÖZELLİKLERİ / الخصائص الآلية							J36MAC	
*opcional *optional *en option *опция *opsiyonel *اختياري								
	EC1540 11 kW	* EC1856 13,2 kW	□ 2,8/3,8 / 4,5m TG825VF 2x3 kW	OG308 / *OG408VF 2,2 kW / *3 kW	TC240 1,5 kW	TH1010 9,2 kW		
	t   1,25   2   2 m/min   40   20   5	t   1,1   2   2 m/min   56   28   6	0...25 m/min	0...0,8 r/min sl/min *0...0,4 0,4...0,8	40 m/min	1 m/min		
	H ≤ SR 193 m						P <sub>TOTAL</sub> (EC1540+ OG308 + TC240) = 14,7 kW P <sub>TOTAL</sub> (EC1856+ OG408VF + TC240) = *17,7 kW	
				480V 60Hz		EC1540 * EC1856 OG308 TC240 TH1010	kW +20% m/min +20%	

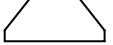
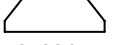
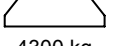
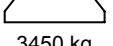
LASTRES INFERIORES / LOWER BALLASTS / LESTS INFÉRIEURS / НИЖНИЙ БАЛЛАСТ / ALT AĞIRLIK TAŞLARI / نقل								J36MAC
	H (m)	15,7	27,7	31,7	39,9	45,5	51,6	
BEX 45 / BTX 45		4	6	8	10	14	16	
BEX 38R / BTX 38R	4100 kg	4	6	8	12	16	----	
BEX 38 / BTX 38		4	6	8	12	----	----	
BEX 28 / BTX 28		8	10	12	----	----	----	
	H (m)	20,3			30,7			
BE 434		8			10			
	H (m)	27,8		32,1		40,5		
BE 442		12		16		20		

H: Altura bajo gancho / Height under hook / Hauteur maximale sous crochet / Высота под крюком / Kanca altı yüksekliği / الارتفاع أسفل الخطاف  
 Para alturas intermedias tomar el lastre correspondiente a la altura superior / For intermediate heights take the ballast corresponding to the higher height / Pour les hauteurs intermédiaires, opter pour le lest correspondant à la hauteur immédiatement supérieure / Для промежуточных высот возьмите балласт, соответствующий большей высоте / Orta yükseklikler için daha üst bir yüksekliğe karşılık gelen ağırlığı alınız. / للارتفاعات البينية يرجى استخدام الثقل العائد للارتفاع الأعلى /



JASO EQUIPOS DE OBRAS Y CONSTRUCCIONES, S.L.



Reservado el derecho a modificaciones sin previo aviso. Declinamos toda responsabilidad derivada de la información proporcionada / Subject to modification, without previous warning. This information is supplied without liability / L'entreprise se réserve le droit de procéder à des modifications sans préavis. Nous déclinons toute responsabilité quant aux informations fournies / Мы оставляем за собой право на внесение изменений без предварительного уведомления. Мы снимаем с себя любую ответственность в отношении предоставленной информации / Önceden bildirilmeksizin değiştirilme hakkı saklıdır. Verilen

Fecha / Date: 15-03-2013

bilgiler için hiçbir sorumluluk kabul etmemekteyiz / حقوق التغيير محفوظة دون إشعار مسبق دون أدنى مسؤولية عن المعلومات المقدمة /

**LISTA DE EMBARQUE / PACKING LIST /**

**J36MAC**

**LISTE DE COLISAGE / СПИСОК ПОСТАВКИ / ÇEKİ LİSTESİ / قائمة التحميل**

DENOMINACIÓN / DENOMINATION / DÉSIGNATION / НАЗВАНИЕ / AÇIKLAMA / اسم		L [m]	A [m]	H [m]	P / W [kg]		
Torre	TR 8RM	8,07	1,19	1,19	2575		
Tower	TR 8M	8,07	1,19	1,19	2515		
Tour	TR 12	12,01	1,19	1,19	2840		
Башня	T 12	12,01	1,18	1,18	2025		
Mast	TR 4	3,96	1,18	1,18	1070		
برج	T 4	4,09	1,18	1,18	795		
	TN 2	2,29	1,19	1,19	785		
Conjunto asiento pista, punta de torre y orientación Slewing table assembly, tower head and slewing mechanism Groupe pivot + porte-flèche + mécanisme d'orientation Сиденье площадки + верхняя секция башни + поворотный механизм Göbek + kulenin kafa bölümü + mekanizma مجموعة وحدة الدوران + رأس البرج + آلية الدوران			6,21	1,31	2,06	2366	
Tramo de pluma Jib section Tronçon de flèche Секция стрелы Vom bölümü أجزاء الذراع			10 10,02 5,11 9,863	0,860 0,860 0,860 0,860	0,987 0,987 0,987 0,987	645 435 204 377	
Polipasto / Hook assembly / Palan / Полиспаст / Kanca takımı / بكرة		SR		0,76	0,15	0,969	102
Carro / Trolley / Chariot / Грузовая тележка / Şaryo / عربة		SR		0,985	1	0,475	85
Contrapluma con plataformas / Counterjib with platforms Contre-flèche avec plateformes / Противовесная консоль с платформами / Platformlu kuşruk / الذراع المقابل مع المنصة			10,55	0,92	0,24	900	
Torre de montaje / Jacking cage / Tour de montage / Монтажная башня / Kaldırma kafesi / برج التركيب		TMU 1.18		7,14	1,76	1,71	3200
Torre de montaje sin puerta, carro, plataforma carro y viga de apoyo Jacking cage without door, trolley, trolley platform and beam assembly Tour de montage sans porte, chariot, plateforme de chariot et poutre de soutien Монтажная башня без двери, грузовой тележки, платформы грузовой тележки и опорной балки Kapısız kaldırma kafesi, vinç köprüsü arabası, vinç köprüsü arabası platformu ve giriş takımı برج التركيب بدون بوابة ، وعربة ومنصة متحركة وعارضة تدعيم			7,14	1,76	1,71	2450	
Plataforma y cabina / Platform and cabin / Plateforme et cabine Платформа и кабина / Platform ve kabin / منصة وكابينة			3,69	1,63	2,25	820	
Base grúa Testero largo Crane base Long carriage Base de la grue. Palonnier long Основание крана. Длинная передняя часть Vinç uzun ^jâ Uzun vinç arabası قاعدة الرافعة مقدمة طويلة (للكابينة)		BTX 28 BTX 38 BTX 38R BTX 45 BEX 28 BEX 38 BEX 38R BEX 45		4,70 6,11 6,11 7,01 4,15 5,56 5,56 6,55	0,64 0,64 0,64 0,64 0,3 0,3 0,3 0,3	1,53 1,53 1,57 1,57 1,27 1,27 1,40 1,41	1346 1576 1792 2065 1160 1390 1590 1863
Mecanismo traslación grúa / Crane travelling mechanism Mécanisme de translation de la grue / Механизм перемещения крана / Yürüyüş mekanizmalı vinç / آلية رفع الرافعة			0,96	0,56	0,66	293	
Lastre / Ballast / Lest / балласт / Alt ağırlik taşlar² / ثقل		□ 2,8m □ 3,8m - □ 4,5m BE 442 BE 434		3,00 4,00 2,09 3,40	0,44 0,34 0,34 0,34	1,30 1,30 2,10 1,69	3700 4100 3450 4300



**JASO EQUIPOS DE OBRAS Y CONSTRUCCIONES, S.L.**



Reservado el derecho a modificaciones sin previo aviso. Declinamos toda responsabilidad derivada de la información proporcionada / Subject to modification, without previous warning. This information is supplied without liability / L'entreprise se réserve le droit de procéder à des modifications sans préavis. Nous déclinons toute responsabilité quant aux informations fournies / Мы оставляем за собой право на внесение изменений без предварительного уведомления. Мы снимаем с себя любую ответственность в отношении предоставленной информации / Önceden bildirilmeksizin değiştirilme hakkı saklıdır. Verilen

Fecha / Date: 15-03-2013

bilgiler için hiçbir sorumluluk kabul etmemekteyiz / حقوق التغيير محفوظة دون إشعار مسبق دون أدنى مسؤولية عن المعلومات المقدمة

T	H (m)						H (m)	T								
1	4,5	T 4 126.32.000	T 4	T 4	T 4 3,96	T 4	4,5	1								
2	16,4	T 12 126.31.500	T 12	T 12	T 12 11,88	T 12	16,4	2								
3	18,5	TN 2 146.32.500	TN 2	TN 2	TN 2 2,16	TN 2	18,5	3								
4	30,4	TR 12 146.30.000	TR 12	TR 12	TR 12 11,88	TR 12	30,4	4								
5	38,3	TR 8M 146.30.800	TR 8M	TR 8M	TR 8M 7,86	TR 8M	38,3	5								
6	46,1	TR 8RM 202.30.000	TR 8RM	TR 8RM	TR 8RM 7,86	TR 8RM	46,1	6								
7	49,9	TX-90/TXXR 202.36.500	TX-90/TXXR	TX-90/TXXR	TX-90/TXXR 0,83	TX-90/TXXR	49,9	7								
8	52,9	T 3-90 133.32.000	T 3-90	T 3-90	T 3-90 2,95	T 3-90	52,9	8								
9	55,8	AN 90	T6-150A 161.31.300	T6-150A	T6-150A 5,82	T6-150A	58,7	9								
10	61,6	AN 90	T6-150 161.31.000	T6-150	TL20 / Tx 150 161.36.000	TL20 / Tx 150	64,5	10								
11	67,5	AN 90 133.21.000	AN 90 133.21.800	AN 150 161.21.000	AND 150 161.21.050	AL 20 153.21.800	ALD 20 160.21.250	AS 20 160.21.010	ASD 20/24 160.21.080	ASR 20 160.21.200	ASRD 20/24 156.21.000	AL20	TL20 153.31.000	TL20	TL20 72,3	12
												TS20A 200.31.500	TS20A	76,2	13	
												TS20 153.31.600	TS20	80,1	14	
												AS 20	AS 20	84	15	
												ASR 20	ASR 20	87,9	16	
												ASRD 20/24	ASRD 20/24	91,7	17	

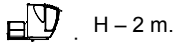

T: Torre / Tower / Tour / Башни / Kuleler / أبراج  
 H: Altura / Height / Hauteur / Высота / Yükseklik / ارتفاع

Otras configuraciones de torre / Other tower configuration / Autres configurations / Прочие конфигурации / Diğer konfigürasyonlar / مكونات أخرى



Transporte / Transport / Transport / Транспортировка / Taşıma / نقل

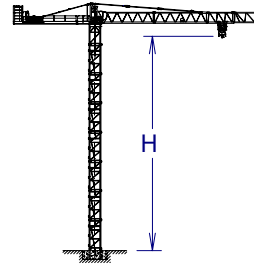

H=38,5 + AN12

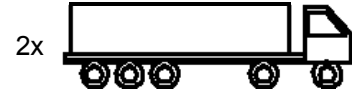

3x HIGH CUBE 40'

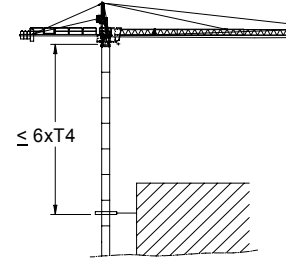

TREPADO / CLIMBING / TÉLESCOPAGE / ЛЕСТНИЦА / TIRMANMA / التسلق

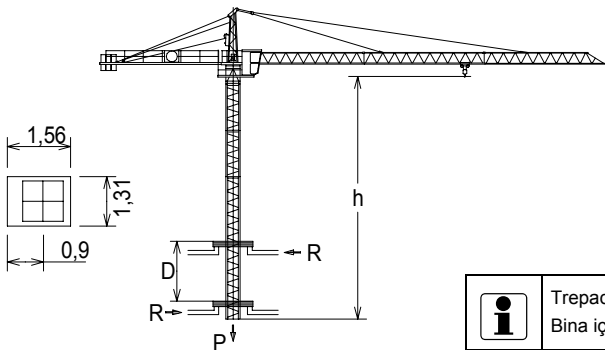

h<sub>max</sub>: 3xTR4 + T12 + 3xT4

h (m)	36
D (m)	5 - 10
P (KN)	262 242
Rmax (KN)	118 239

TR4: 800.32.300



Trepado interno / Internal climbing. / Télescopage intérieur / Внутренняя лестница / Bina içi tırmanma./ التسلق الداخلي

Viento fuera de servicio / Out of service wind / Vitesse du vent hors service / Ветровая нагрузка в покое / Rüzgar devre dışı / الريح خارج الخدمة

- Consultar / Consult / Nous consulter / Консультируйтесь / Danışınız / الرجوع إلى
- En servicio / In service / En service / В работе / Devrede / في الخدمة
- Fuera de servicio / Out of service / Hors service / В покое / Devre dışı / خارج الخدمة



JASO EQUIPOS DE OBRAS Y CONSTRUCCIONES, S.L.

Ctra./Rd. Madrid - Irún Km. 415  
 20.213 IDIAZABAL [Gipuzkoa]  
 ESPAÑA / SPAIN  
 P.O. Box, 23 - 20.200 BEASAIN

Tel. +34 943 - 18 70 00  
 Fax. +34 943 - 18 70 20  
 E-mail: jaso@jaso.com  
 http://www.jaso.com

Fecha / Date: 15-03-2013

Reservado el derecho a modificaciones sin previo aviso. Declinamos toda responsabilidad derivada de la información proporcionada / Subject to modification, without previous warning. This information is supplied without liability / L'entreprise se réserve le droit de procéder à des modifications sans préavis. Nous déclinons toute responsabilité quant aux informations fournies / Мы оставляем за собой право на внесение изменений без предварительного уведомления. Мы снимаем с себя любую ответственность в отношении предоставленной информации / Önceden bildirilmeksizin değiştirilme hakkı saklıdır. Verilen bilgiler için hiçbir sorumluluk kabul etmemekteyiz / حقوق التغيير محفوظة دون إشعار مسبق. دون أدنى مسؤولية عن المعلومات المقدمة.

FEM 1001



TERA MÜMESSİLLİK İÇ VE DIŞ TİCARET LİMİTED ŞİRKETİ.  
 Şerifali Mah. Turgut özal Blv.  
 No:169 K:2 Umranıye  
 34775 İstanbul TÜRKİYE  
 Tel: +90 216 508 18 00  
 Faks: +90 216 508 10 71  
 info@teramak.com.tr  
 www.teramak.com.tr